



DUCT ACCESS DOORS

Models ADH and ADC

KEES duct access doors are easy to install and provide an economical means of access to the inside of ductwork. The fold-over tabs lock the frame into the opening. Sturdy double-wall insulated doors and gasketing prevent air leakage and heat transfer. Standard doors are suitable for low-to medium-pressure duct systems up to 4.5" w.g. while high-pressure versions are rated up to 10" w.g.



**STANDARD DUCT ACCESS DOOR WITH CAM LATCHES
(INSET PHOTO HINGED HIGH-PRESSURE DOOR)**

STANDARD SIZES

WIDTH X HEIGHT
6 X 6
8 X 8
10 X 10
12 X 12
14 X 14
16 X 16
18 X 18
20 X 20
24 X 24
24 X 36
30 X 30
24 X 48
36 X 36

Other sizes available upon request.

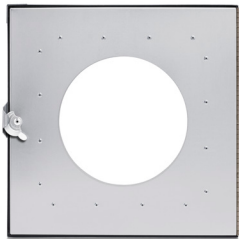

**VIEW PORTS
AVAILABLE**



2" DOOR



**DOORS FOR
FIBERGLASS DUCTS**



**FOR ROUND
OR OVAL DUCTS**



DUCT ACCESS DOORS

Retaining and Lock Options



RETAINING CHAIN FOR CAMMED DOORS



PADLOCK HASP FOR HINGED DOORS*



CYLINDER LOCK FOR HINGED DOORS



PADLOCK EYES FOR HINGED DOORS*

* LOCK IS PROVIDED BY OTHERS



DUCT ACCESS DOORS

Technical drawings of options

FOR FIBERGLASS DUCTS (-F)

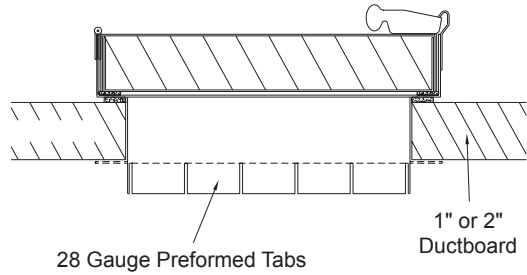
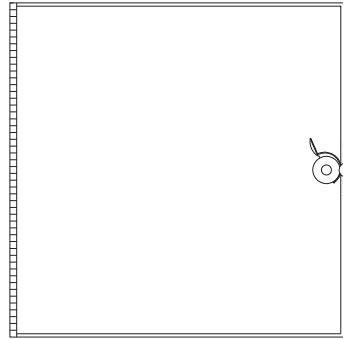

DOORS WITH VIEW PORTS

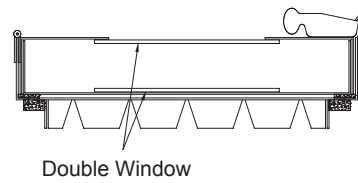
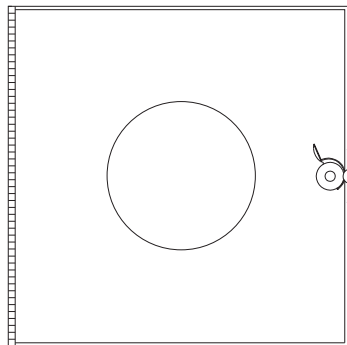

FOR ROUND AND OVAL DUCTS (-R)

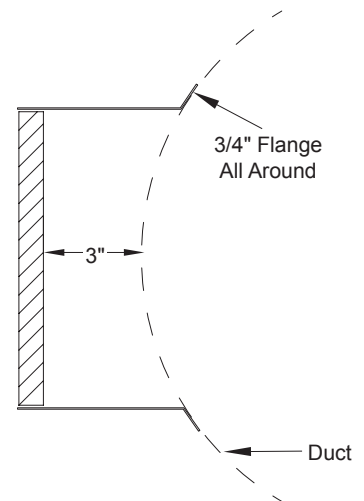
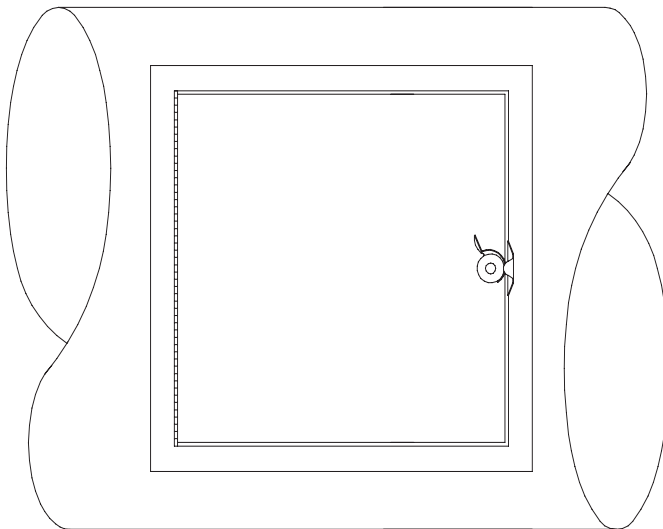



DUCT ACCESS DOORS

Models ADH and ADC

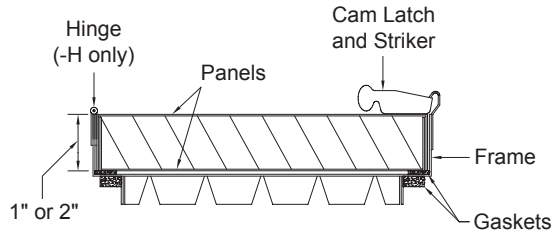
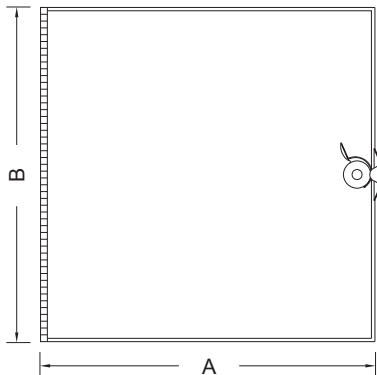

QTY	SIZE A X B	DUCT OPENING	NUMBER OF LATCHES				DUCT DIAMETER (-R)
			ADC	ADH	ADC-HP	ADH-HP	
	6 X 6	4.875 X 4.875	2	1	4	3	
	8 X 8	6.875 X 6.875	2	1	4	3	
	10 X 10	8.875 X 8.875	2	1	4	3	
	12 X 12	10.875 X 10.875	2	1	4	3	
	14 X 14	12.875 X 12.875	2	1	4	3	
	16 X 16	14.875 X 14.875	4	2	8	6	
	18 X 18	16.875 X 16.875	4	2	8	6	
	20 X 20	18.875 X 18.875	4	2	8	6	
	24 X 24	22.875 X 22.875	4	2	8	6	
	24 X 36	22.875 X 34.875	6	3	*	*	
	30 X 30	28.875 X 28.875	8	4	*	*	
	24 X 48	22.875 X 46.875	8	4	*	*	
	36 X 36	34.875 X 34.875	10	5	*	*	

SPECIFICATIONS

- 22-gauge door frame
- 24-gauge door panels
- Fiberglass insulation
- Foam gasket
- Cam latch and striker
- Piano hinge (if applicable)

Note: Hinge mounted on "B" side

OPTIONS

MATERIAL

- Galvanized Steel (Std.)
- Aluminum
- 304 SS
- 316 SS

INSULATION

- 1" Thick (Std.)
- 2" Thick
- Fiberglass Ductboard (-F)
Thickness: _____

VIEW PORT

- Plexiglass
- Lexan
- Laminated Safety Glass

OPTIONAL ACCESSORIES

- Chain (ADC only)
- Cylinder Cam Lock (ADH Only)
- Hasp (ADH Only)
- Padlock Eyes (ADH Only)
- Ventlock 100 Lever Handles

HINGE AND LATCHES

- Cam Latches Only (-C)
- Piano Hinge & Latches (-H)

PRESSURE RATING

- 4.5" w.g. (Std.)
- 10" w.g. (-HP)

* Use AD-K-HP for high pressure door of this size

To maintain our policy of continuous product development, we reserve the right to change prices, specifications, ratings, and dimensions without notice or obligation.

Project/Location		KEES INCORPORATED 400 South Industrial Drive Elkhart Lake, WI 53020 Ph: 920.876.3391 F: 920.876.3065 www.kees.com
Engineer/Architect		
Contractor		
Representative		
	Date	